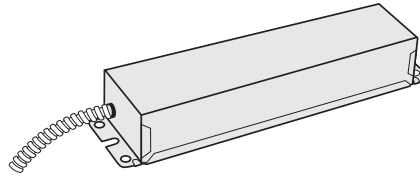


# B30HV

## Installation Instructions

EMERGENCY LIGHTING EQUIPMENT



PHILIPS  
bodine



### **! IMPORTANT SAFEGUARDS !**

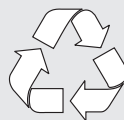
WHEN USING ELECTRICAL EQUIPMENT, BASIC SAFETY PRECAUTIONS SHOULD ALWAYS BE FOLLOWED, INCLUDING THE FOLLOWING:

## READ AND FOLLOW ALL SAFETY INSTRUCTIONS

1. To prevent high voltage from being present on red & yellow output leads prior to installation, inverter connector must be open. Do not join inverter connector until installation is complete and AC power is supplied to the emergency ballast.
2. This product is for use with most 2' through 8' (14 W - 215 W) T5, T8, T9, T10 and T12 single pin or bipin fluorescent lamps, including energy saving, circline, U-shaped and rapid-start (4-pin) compact fluorescent lamps.
3. Make sure all connections are in accordance with the National Electrical Code or Canadian Electrical Code and any local regulations.
4. To reduce the risk of electric shock, disconnect both normal and emergency power supplies and inverter connector of the emergency ballast before servicing.
5. This emergency ballast is for factory or field installation.
6. This product is suitable for damp locations where the ambient temperature is +5°C minimum, +50°C maximum. Not suitable for heated air outlets and wet or hazardous locations.
7. An unswitched AC power source is required (347 through 480 VAC, 50 or 60 Hz).
8. Do not install near gas or electric heaters.
9. The use of accessory equipment not recommended by the manufacturer may cause an unsafe condition.
10. Do not use this product for other than intended use.
11. Servicing should be performed by qualified service personnel.
12. Do not attempt to service the battery. A sealed, no-maintenance battery is used that is not field replaceable. Contact the manufacturer for information on service.

**CAUTION:** Verify that all replacement lamp types marked on the installed luminaire are also identified as suitable for use with this inverter/charger pack.

## SAVE THESE INSTRUCTIONS



Ni - Cd

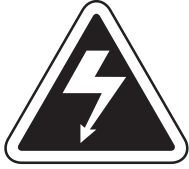
**THIS PRODUCT CONTAINS A RECHARGEABLE NICKEL-CADMIUM BATTERY.  
THE BATTERY MUST BE RECYCLED OR DISPOSED OF PROPERLY.**

01/05/15

© Philips Emergency Lighting

236 Mt. Pleasant Rd. • Collierville, TN USA 38017-2752 • Tech Support 888-263-4638 • Fax 901-853-5009 • [www.philips.com/bodine](http://www.philips.com/bodine)  
73000006

# INSTALLATION

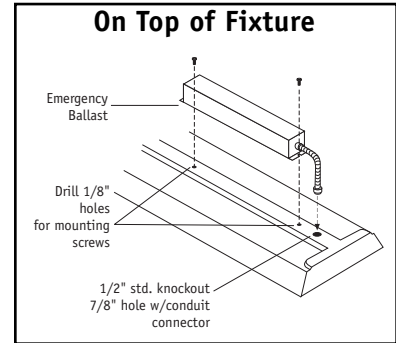


**WARNING: TO PREVENT HIGH VOLTAGE FROM BEING PRESENT ON RED & YELLOW OUTPUT LEADS PRIOR TO INSTALLATION, INVERTER CONNECTOR MUST BE OPEN. DO NOT JOIN INVERTER CONNECTOR UNTIL INSTALLATION IS COMPLETE AND AC POWER IS SUPPLIED TO THE EMERGENCY BALLAST.**

**NOTE:** Make sure that the necessary branch circuit wiring is available. An unswitched source of power is required. The emergency ballast must be fed from the same branch circuit as the AC ballast.

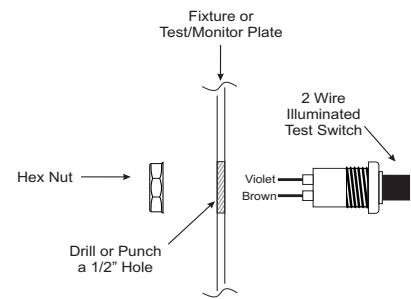
## STEP #1 ▶ INSTALLING THE EMERGENCY BALLAST

- > Disconnect AC power from the fixture. Install the emergency ballast as shown. **Remote mounting distance must be less than half the maximum remote mounting distance of the AC ballast. Consult AC ballast manufacturer before remote installation.**



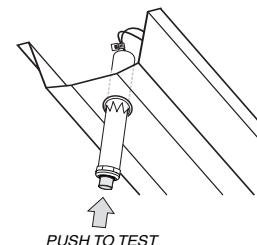
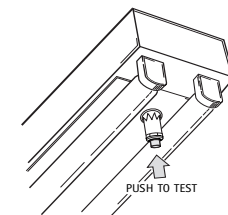
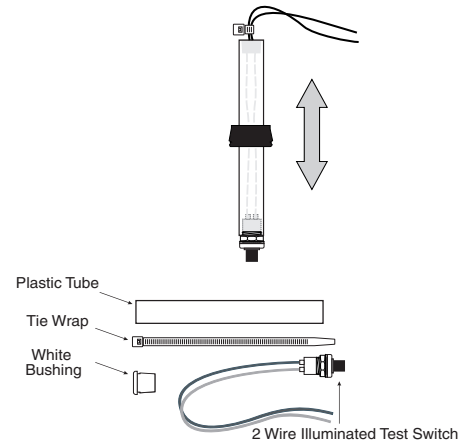
## STEP #2a ▶ INSTALLING THE 2W-ITS ON WALL PLATE OR FIXTURE SURFACE

- > Drill a 1/2" hole and install the test switch as shown.
- > Wire the test switch per wiring diagrams provided on these instructions.
- > If wired correctly, the 2W-ITS indicator light should be ON when AC power is supplied to the fixture, indicating that the emergency ballast battery is charging. After installing, mark with the "PUSH TO TEST" and "CHARGING INDICATOR LIGHT" labels.



## STEP #2b ▶ INSTALLING THE 2W-ITS ON THE BALLAST CHANNEL COVER

- > Drill or punch a 7/8 inch hole in ballast channel cover and insert bushing.
- > Slide the 2W-ITS tube up or down to adjust the height and visibility of the charging indicator light.
- > If the tube is too long, cut the plastic tubing to necessary length.
- > After cutting the tube to the proper length, assemble the 2W-ITS. To assemble the 2W-ITS:
  - > Feed the switch leads through the plastic tubing.
  - > Insert the white bushing in the opposite end of tube from the switch body.
  - > Pull switch leads and use provided tie wrap to secure leads snug against white bushing.
  - > Unscrew hex nut to apply tension to leads.



## STEP #3 ► WIRING THE EMERGENCY BALLAST

- > Determine the type of AC ballast installed in the fixture.
- > Select the appropriate wiring diagram on the following pages to connect the emergency ballast to the AC ballast and lamp(s). Make electrical connections in accordance with the National Electrical Code, Canadian Electrical Code and any local regulations.
- > After installation is complete, supply AC power to the emergency ballast and join the inverter connector.
- > At this point, power should be connected to both the AC ballast and the emergency ballast, and the Charging Indicator Light should illuminate indicating the battery is charging.
- > A short-term discharge test may be conducted after the emergency ballast has been charging for one hour. Charge for 24 hours before conducting a long-term discharge test. Refer to OPERATION.
- > In a readily visible location, attach the label "**CAUTION - This Unit Has More Than One Power Connection Point. To Reduce The Risk Of Electric Shock, Disconnect Both The Branch Circuit-Breakers Or Fuses And Emergency Power Supplies Before Servicing.**"

## OPERATION

---

When AC power is applied, the charging indicator light is illuminated, indicating that the battery is being charged. When power fails, the emergency ballast automatically switches to emergency power (internal battery), operating either one or two lamps at reduced illumination for at least 90 minutes. When AC power is restored, the emergency ballast returns to the charging mode and delays AC ballast operation for approximately three seconds to prevent false-tripping of AC ballast (end-of-lamp-life) shutdown circuits.

## MAINTENANCE

---

Although no routine maintenance is required to keep the emergency ballast functional, it should be checked periodically to ensure that it is working. The following schedule is recommended:

1. Visually inspect the charging indicator light monthly. It should be illuminated.
2. Test the emergency operation of the fixture at 30-day intervals for a minimum of 30 seconds. One or two lamps should operate at reduced illumination.
3. Conduct a 90-minute discharge test once a year. One or two lamps should operate at reduced illumination for at least 90 minutes.

**! REFER ANY SERVICING INDICATED BY THESE CHECKS TO QUALIFIED PERSONNEL !**

# WIRING DIAGRAMS

The following diagrams are typical schematics only.  
The unit may be used with other ballasts.  
Consult the factory for other wiring diagrams.

## EMERGENCY BALLAST AND AC BALLAST MUST BE FED FROM THE SAME BRANCH CIRCUIT

TYPICAL SCHEMATICS ONLY. MAY BE USED WITH OTHER BALLASTS.  
CONSULT THE FACTORY FOR OTHER WIRING DIAGRAMS.

Table 1 - Lamp Compatibility

LAMP DIAMETER (T5, T8, T9, T10, T12)	BASE	WATTAGE (Length)	NO. of LAMPS (EMERGENCY)	BLUE/ORANGE CONNECTOR	YELLOW/RED CONNECTOR
1", 1 1/4", 1 1/2"	Single or Bipin	17 - 40 W (2' - 4')	1	CLOSED	OPEN
		40 - 215 W (5' - 8')	2	OPEN	CLOSED
			1	OPEN	CLOSED
Long Compact	4-PIN (2G11)	18 - 39 W	1	CLOSED	OPEN
		40 - 55 W	1	CLOSED	OPEN
Twin/Quad/Tripole Twin-Tube Compact	4-PIN (G24q, GX24q)	18 - 42 W	1	CLOSED	OPEN
2D	4-PIN (GR10q)	16 - 55 W	1	CLOSED	OPEN
		55 W	1	OPEN	CLOSED
T5	HO Circine 4-PIN (2GX13)	22 - 55 W	1	CLOSED	OPEN
		T5 HE	14 W	1	CLOSED
	2		OPEN	CLOSED	
	21-35 W*		1	CLOSED	OPEN
	T5 HO	24 W	1	CLOSED	OPEN
			2	OPEN	CLOSED
39-54 W	1	CLOSED	OPEN		

\*The B30-HV cannot start the 35W T5 lamp unless the lamp is in an ambient of 20° C or greater.

## WIRING DIAGRAMS FOR 1-LAMP EMERGENCY OPERATION

FIG A ONE (1) LAMP INSTANT START BALLAST

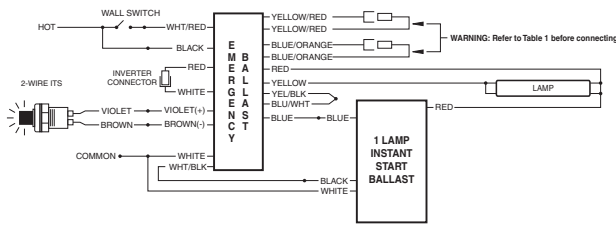


FIG B ONE (1) LAMP RAPID START BALLAST

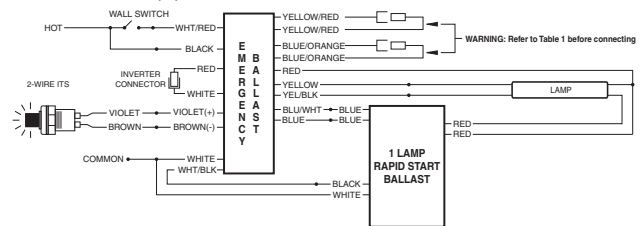


FIG C TWO (2) LAMP INSTANT START BALLAST

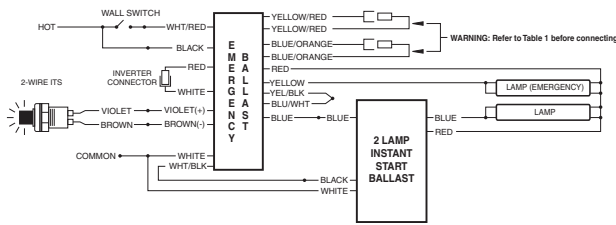


FIG D TWO (2) LAMP RAPID START BALLAST

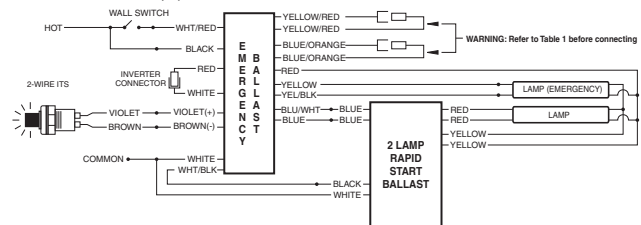


FIG E THREE (3) LAMP INSTANT START BALLAST

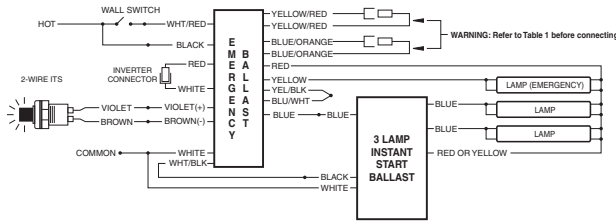


FIG F THREE (3) LAMP RAPID START BALLAST

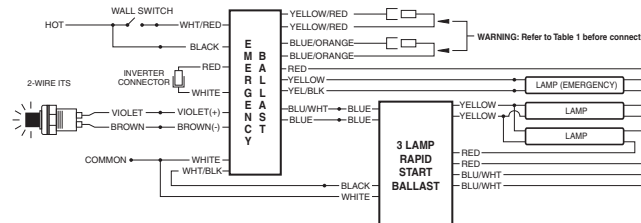


FIG G FOUR (4) LAMP INSTANT START BALLAST

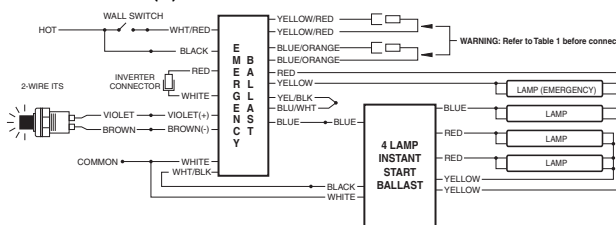


FIG H FOUR (4) LAMP RAPID START BALLAST

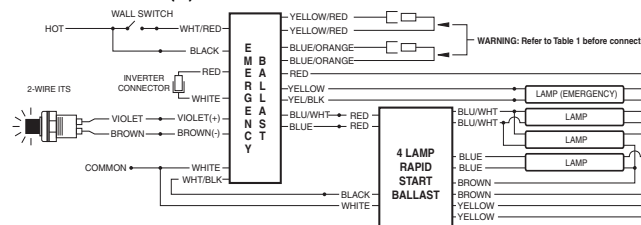
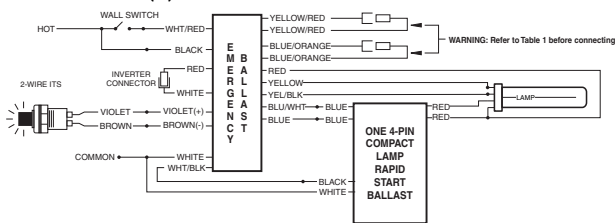
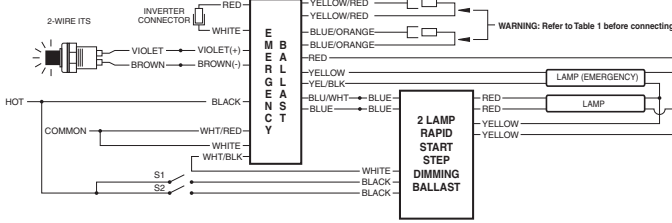


FIG I ONE (1) 4-PIN COMPACT LAMP RAPID START BALLAST



# WIRING DIAGRAMS FOR 1-LAMP EMERGENCY OPERATION

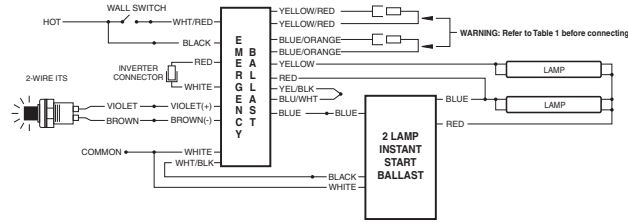
**FIG J TWO (2) LAMP RAPID START STEP DIMMING BALLAST**



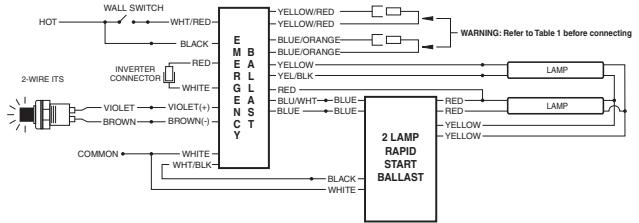
THE WHITE/BLACK LEAD MUST CONNECT TO THE WHITE LEAD OF THE STEP-DIMMING BALLAST ASSOCIATED WITH THE EMERGENCY BALLAST ONLY. CONNECTIONS TO OTHER BALLASTS OR FIXTURES COULD RESULT IN ABNORMAL OPERATION AND CAUSE PRODUCT DAMAGE.

# WIRING DIAGRAMS FOR 2-LAMP EMERGENCY OPERATION (See table 1 for 2-lamp compatibility)

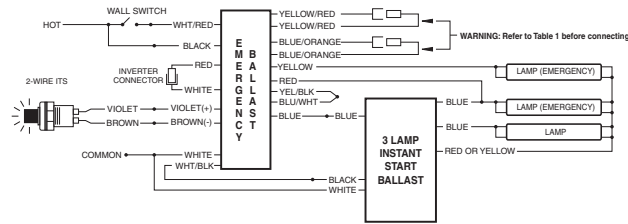
**FIG K TWO (2) LAMP INSTANT START BALLAST**



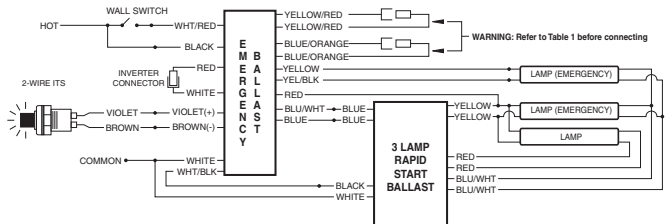
**FIG L TWO (2) LAMP RAPID START BALLAST**



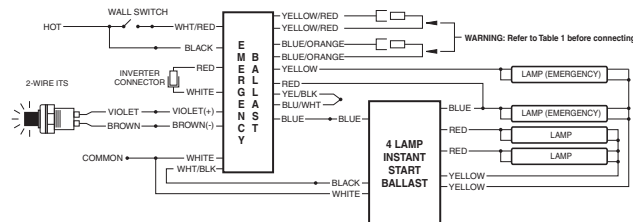
**FIG M THREE (3) LAMP INSTANT START BALLAST**



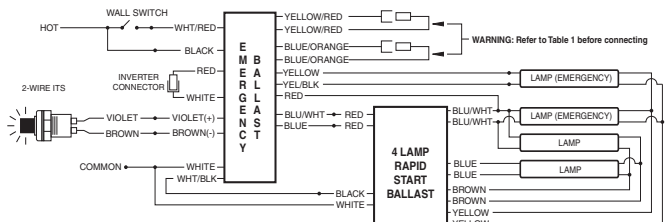
**FIG N THREE (3) LAMP RAPID START BALLAST**



**FIG O FOUR (4) LAMP INSTANT START BALLAST**

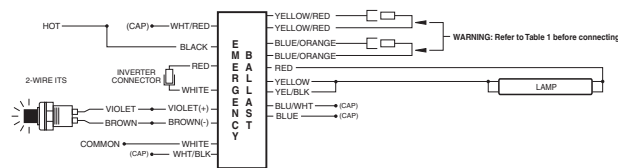


**FIG P FOUR (4) LAMP RAPID START BALLAST**



# WIRING DIAGRAM FOR EMERGENCY-ONLY FIXTURES (See table 1 for 2-lamp compatibility)

**FIG Q ONE (1) LAMP WITHOUT AC BALLAST**



**FIG R TWO (2) LAMPS WITHOUT AC BALLAST**

