

B30ST

Installation Instructions

SELF-TESTING EMERGENCY LIGHTING EQUIPMENT

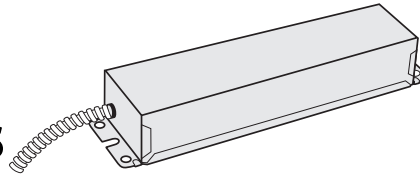

PHILIPS
bodine



! IMPORTANT SAFEGUARDS !

WHEN USING ELECTRICAL EQUIPMENT, BASIC SAFETY PRECAUTIONS SHOULD ALWAYS BE FOLLOWED, INCLUDING THE FOLLOWING:

READ AND FOLLOW ALL SAFETY INSTRUCTIONS

1. To prevent high voltage from being present on red & yellow output leads prior to installation, inverter connector must be open. Do not join inverter connector until installation is complete and AC power is supplied to the emergency ballast.
2. This product is for use with most 2' through 8' (17 W - 215 W) T5, T8, T9, T10 and T12 single pin or bipin fluorescent lamps, including energy saving, circline, and U-shaped fluorescent lamps. Also operates Philips InstantFit LED 2' to 4' 8.5 W - 16.5 W T8 and InstantFit LED U Bend 6" 16.5 W T8 lamps, including 9290011181, 9290011182, 9290011183, 9290011184, 9290011185, 9290011186, 9290011240, 9290011241, 9290011242, 9290002862, 9290002841, 9290002842, 9290002880, 9290002881, 9290002882, 9290002883, 9290011196, 9290011197, 9290011198, 9290011199, 9290011513, 9290011514, 9290011515, 9290011585, 9290011586, 9290011587, 9290011588..
3. Make sure all connections are in accordance with the National Electrical Code, Canadian Electrical Code and any local regulations.
4. To reduce the risk of electric shock, disconnect both normal and emergency power supplies and inverter connector of the emergency ballast before servicing.
5. This emergency ballast is for factory or field installation.
6. This product is suitable for damp locations where the ambient temperature is 0°C minimum, +50°C maximum. Not suitable for heated air outlets, wet or hazardous locations.
7. An unswitched AC power source is required (120 through 277 VAC, 50/60 Hz).
8. Do not install near gas or electric heaters.
9. The use of accessory equipment not recommended by the manufacturer may cause an unsafe condition.
10. Do not use this product for other than intended use.
11. Servicing should be performed by qualified service personnel.
12. Do not attempt to service the battery. A sealed, no-maintenance battery is used that is not field replaceable. Contact the manufacturer for information on service.

CAUTION: Verify that all replacement lamp types marked on the installed luminaire are also identified as suitable for use with this inverter/charger pack.

SAVE THESE INSTRUCTIONS



Ni - Cd

**THIS PRODUCT CONTAINS A RECHARGEABLE NICKEL-CADMIUM BATTERY.
THE BATTERY MUST BE RECYCLED OR DISPOSED OF PROPERLY.**

05/08/15

© Philips Emergency Lighting

236 Mt. Pleasant Rd. • Collierville, TN USA 38017-2752 • Tech Support 888-263-4638 • Fax 901-853-5009 • www.philips.com/bodine
70100247

INSTALLATION

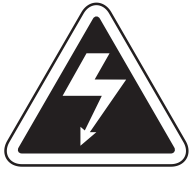

WARNING: TO PREVENT HIGH VOLTAGE FROM BEING PRESENT ON RED & YELLOW OUTPUT LEADS PRIOR TO INSTALLATION, INVERTER CONNECTOR MUST BE OPEN. DO NOT JOIN INVERTER CONNECTOR UNTIL INSTALLATION IS COMPLETE AND AC POWER IS SUPPLIED TO THE EMERGENCY BALLAST.

NOTE: Make sure that the necessary branch circuit wiring is available. An unswitched source of power is required. The emergency ballast must be fed from the same branch circuit as the AC ballast.

STEP #1 ▶ INSTALLING THE EMERGENCY BALLAST

- > Disconnect AC power from the fixture. Install the emergency ballast as shown. **Remote mounting distance must be less than half the maximum remote mounting distance of the AC ballast. Consult AC ballast manufacturer before remote installation.**

STEP #2a ▶ INSTALLING THE 2W-ITS ON WALL PLATE OR FIXTURE SURFACE

- > Drill a 1/2" hole and install the test switch as shown.
- > Wire the test switch per wiring diagrams provided on these instructions.
- > If wired correctly, the 2W-ITS indicator light should be ON when AC power is supplied to the fixture, indicating that the emergency ballast battery is charging. After installing, mark with the "PUSH TO TEST" and "CHARGING INDICATOR LIGHT" labels.

STEP #2b ▶ INSTALLING THE 2W-ITS ON THE BALLAST CHANNEL COVER

- > Drill or punch a 7/8 inch hole in ballast channel cover and insert bushing.
- > Slide the 2W-ITS tube up or down to adjust the height and visibility of the charging indicator light.
- > If the tube is too long, cut the plastic tubing to necessary length.
- > After cutting the tube to the proper length, assemble the 2W-ITS. To assemble the 2W-ITS:
 - > Feed the switch leads through the plastic tubing.
 - > Insert the white bushing in the opposite end of tube from the switch body.
 - > Pull switch leads and use provided tie wrap to secure leads snug against white bushing.
 - > Unscrew hex nut to apply tension to leads.

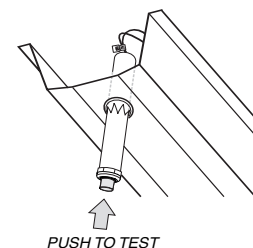
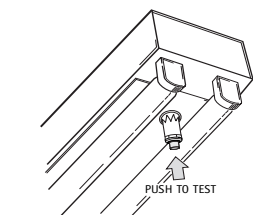
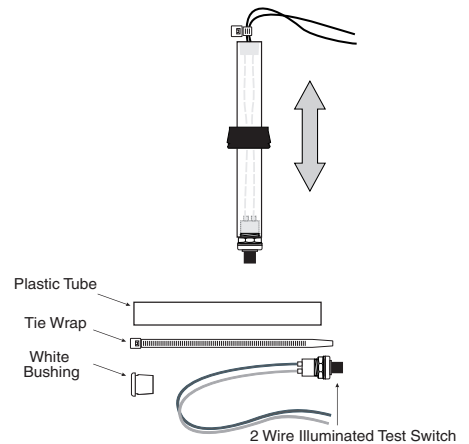
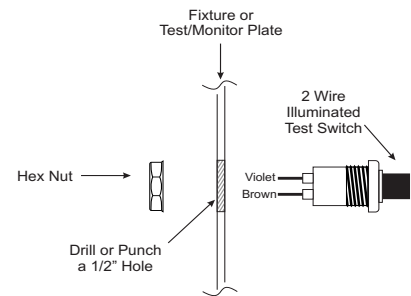
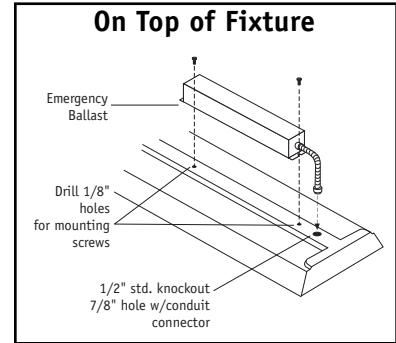

STEP #3 WIRING THE EMERGENCY BALLAST

- > Determine the type of AC ballast installed in the fixture.
- > Select the appropriate wiring diagram on the following pages to connect the emergency ballast to the AC ballast and lamp(s). Make electrical connections in accordance with the National Electrical Code, Canadian Electrical Code and any local regulations.
- > After installation is complete, supply AC power to the emergency ballast and join the inverter connector.
- > At this point, power should be connected to both the AC ballast and the emergency ballast, and the Charging Indicator Light should illuminate indicating the battery is charging.
- > A short-term discharge test may be conducted after the emergency ballast has been charging for one hour. Charge for 24 hours before conducting a long-term discharge test. Refer to OPERATION.
- > In a readily visible location, attach the label "**CAUTION - This Unit Has More Than One Power Connection Point. To Reduce The Risk Of Electric Shock, Disconnect Both The Branch Circuit-Breakers Or Fuses And Emergency Power Supplies Before Servicing.**"

OPERATION

During normal operation, AC power is applied and the self-testing emergency ballast charges the battery. Connecting the (red and white) inverter connector wires enables the emergency circuit, and supplies power to the control/monitor circuit and charging indicator light. The self-testing emergency ballast continually monitors the battery voltage, comparing it to a preset limit. Should the unit detect an unusual voltage condition, the indicator light will flash.

When AC power fails, the self-testing emergency ballast automatically switches to emergency mode, keeping one or two lamp illuminated at a reduced lumen output for a minimum of 90 minutes. When AC power is restored, the self-testing emergency ballast returns to charging mode and delays AC ballast operation for approximately 3 seconds to prevent false-tripping of AC ballast (end of lamp life) shutdown circuits.

SELF-TESTING OPERATION

This unit contains a control/monitor circuit that automatically performs a 30-second discharge test every 28 days, and a full 90-minute discharge test once a year. During routine testing, the self-testing emergency ballast simulates an AC power failure causing the unit to automatically switch to emergency mode. The unit will monitor the operation of the lamps, battery voltage, discharge current, and emergency duration. If the emergency system functions properly, then the unit will return to normal mode. Should the unit detect any problems, the indicator light will flash continually until the condition has been corrected and the unit passes the next test.

If the condition has not been corrected by the next scheduled test, the unit will once again detect the failure and signal the failure indicator.

To cancel a test, turn the wall switch ON (or OFF if switch is already on), wait 5 seconds, then turn it OFF (ON).

To perform manual self-test push and hold 2 wire ITS for minimum 5 second. Once 2 wire ITS is released emergency ballast will perform 30 second diagnostic test. During this test unit will monitor the operation of the lamps, battery voltage, discharge current. If the emergency system functions properly, then the unit will return to normal mode. Should the unit detect any problems, the indicator light will flash per failure condition (see Troubleshooting guide) until the condition has been corrected and or the unit passes the next test.

MAINTENANCE

This self-testing emergency ballast automatically performs required routine testing. Results are reported to maintenance personnel via the indicator light.

Note: Maintenance personnel should periodically check the indicator light. If the indicator light is flashing, go through all steps of *Troubleshooting Guide*.

TROUBLESHOOTING GUIDE

STATUS INDICATOR	PROBLEM	CORRECTIVE ACTION
Light on steady, not flashing	None	None, Unit is Operating Correctly.
Flashing 2 times every 10 seconds	Battery voltage is outside limits	Let battery charge. If after an hour failure is still indicated, see action below.
Flashing 3 times every 10 seconds	Battery charging current is outside limits	Check that fixture wiring is in accordance with proper wiring diagram.
Flashing 4 times every 10 seconds	Battery discharge is too low during scheduled self test	<ol style="list-style-type: none"> 1. Check to make sure lamps are good (operational and specified for self-testing emergency ballast) and in place. 2. Check to see if brown connector is properly used. (See Table 1.) 3. Check that fixture wiring is in accordance with proper wiring diagram. 4. Allow unit to charge for 24 hours. Perform manual test. If flashing continues, emergency ballast should be replaced.
Continuous fast flashing	Battery discharge is too high during scheduled self test	

Failure Status will be reset when the unit passes:

- The next automatic test, or
- A successful manual self-test, or
- An actual power failure exceeding 10 seconds.

NOTE: It is normal for the indicator light to remain off for a few minutes on initial start-up or after a very long power outage (discharge), as the battery voltage rises to normal range. Refer to the Troubleshooting Guide if this condition persists.

B30ST WIRING DIAGRAMS

The following diagrams are typical schematics only. May be used with other ballasts.

Consult the factory for other wiring diagrams.

EMERGENCY BALLAST AND AC BALLAST MUST BE FED FROM THE SAME BRANCH CIRCUIT.

Table 1 - Lamp Compatibility

LAMP DIAMETER (T5, T8, T9, T10, T12)	BASE	WATTAGE (Length)	NO. of LAMPS (EMERGENCY)	BROWN CONNECTOR	VIOLET CONNECTOR
1", 1¼", 1½" (T8, T9, T10, T12)	Single or Bipin	17 - 40 W (2' - 4')	1	CLOSED	OPEN
		40 - 215 W (5' - 8')	2	OPEN	CLOSED
			1	OPEN	CLOSED
Long Compact	4-PIN (G11)	18 - 55 W	1	CLOSED	OPEN
Twin/Quad/Triple Twin-Tube Compact	4-PIN (G24q, GX24q)	18 - 42 W	1	CLOSED	OPEN
Philips InstantFit LED T8	Bipin	8.5 - 16.5W (2'-4')	1	CLOSED	OPEN
Philips InstantFit LED T8 U Bend 6"	Bipin	16.5W	1	CLOSED	OPEN
Philips InstantFit LED Twin-Tube Compact	4-PIN	16.5W 22"	1	CLOSED	OPEN
2D	4-PIN (GR10q)	16 - 55 W	1	CLOSED	OPEN
T5 HO	HO Circline 4-PIN (ZGX13)	22 - 55 W	1	CLOSED	OPEN
	Miniature Bipin	24 - 54W (2' - 4')	1	CLOSED	OPEN
T5	Miniature Bipin	14 - 35W (2' - 5')	1	CLOSED	OPEN

EMERGENCY BALLAST AND AC BALLAST MUST BE FED FROM THE SAME BRANCH CIRCUIT
 TYPICAL SCHEMATICS ONLY. MAY BE USED WITH OTHER BALLASTS. CONSULT THE FACTORY FOR OTHER WIRING DIAGRAMS.

WIRING DIAGRAMS FOR 1-LAMP EMERGENCY OPERATION

INSTANT START AC BALLASTS

RAPID START AC BALLASTS

FIG A ONE (1) LAMP INSTANT START BALLAST

FIG B ONE (1) LAMP RAPID START BALLAST

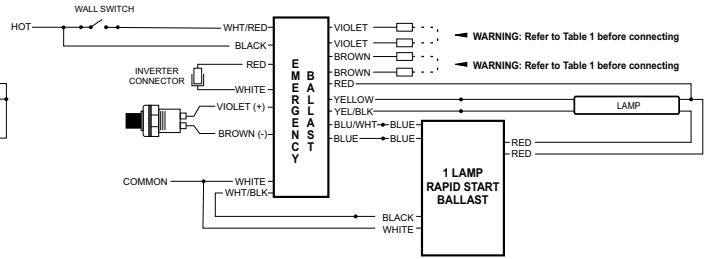
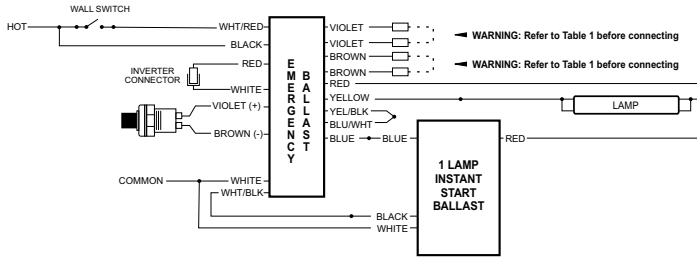

FIG C TWO (2) LAMP INSTANT START BALLAST

FIG D TWO (2) LAMP RAPID START BALLAST

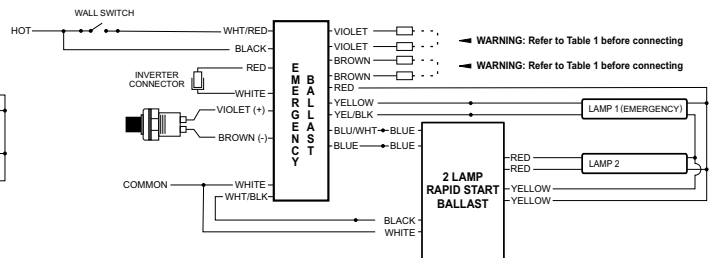
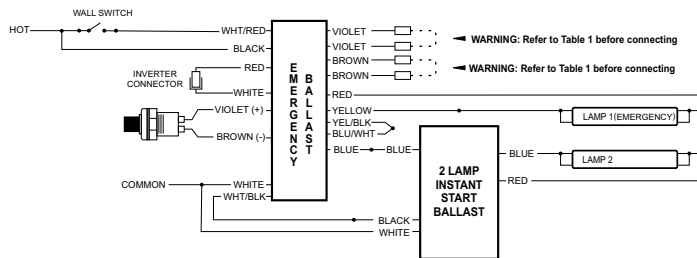

FIG E THREE (3) LAMP INSTANT START BALLAST

FIG F THREE (3) LAMP RAPID START BALLAST

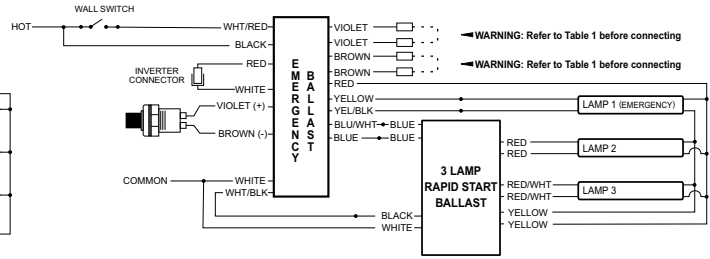
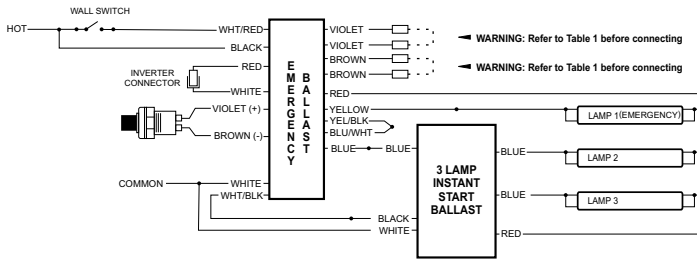

FIG G FOUR (4) LAMP INSTANT START BALLAST

FIG H FOUR (4) LAMP RAPID START BALLAST

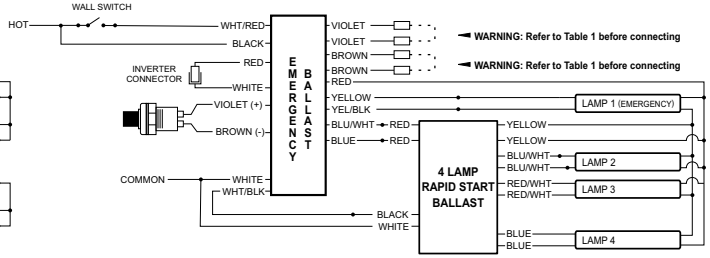
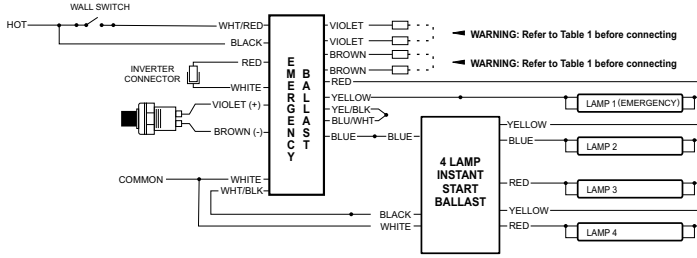

FIG I ONE (1) 4-PIN COMPACT LAMP RAPID START BALLAST

FIG J TWO (2) 4-PIN COMPACT LAMP RAPID START BALLAST

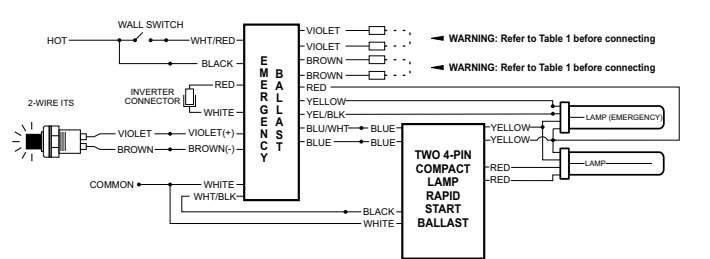
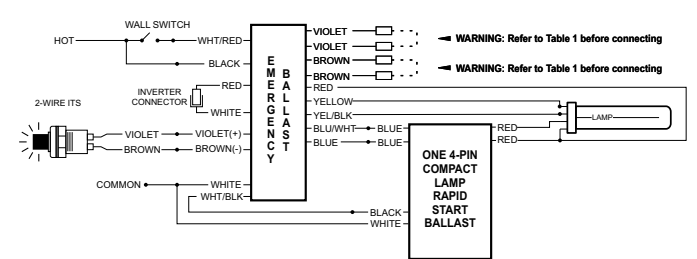
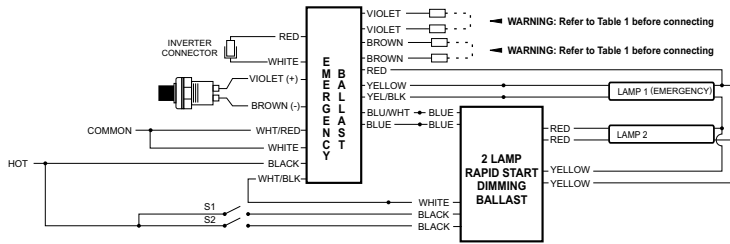

FIG K TWO (2) LAMP RAPID START STEP DIMMING BALLAST



NOTE: FOR FIG K

THE WHITE/BLACK LEAD MUST CONNECT TO THE WHITE LEAD OF THE STEP-DIMMING BALLAST ASSOCIATED WITH THE EMERGENCY BALLAST ONLY. CONNECTIONS TO OTHER BALLASTS OR FIXTURES COULD RESULT IN ABNORMAL OPERATION AND CAUSE PRODUCT DAMAGE.

WIRING DIAGRAMS FOR 2-LAMP EMERGENCY OPERATION (2' - 4', 17- 40 W LAMPS ONLY)

Two-lamp emergency operation is not possible with all ballasts. Consult the factory for any ballast other than those shown.

FIG L TWO (2) LAMP INSTANT START BALLAST

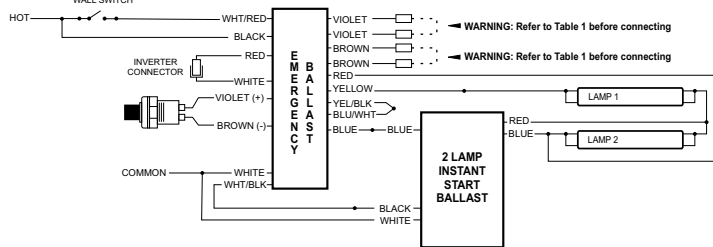

FIG M TWO (2) LAMP RAPID START BALLAST

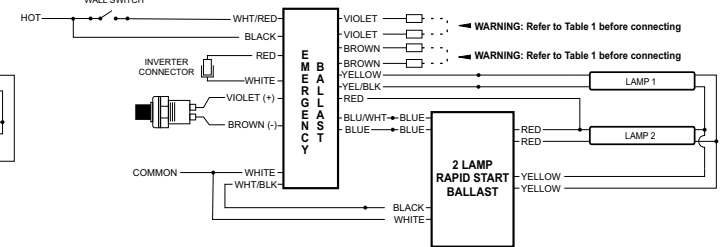

FIG N THREE (3) LAMP INSTANT START BALLAST

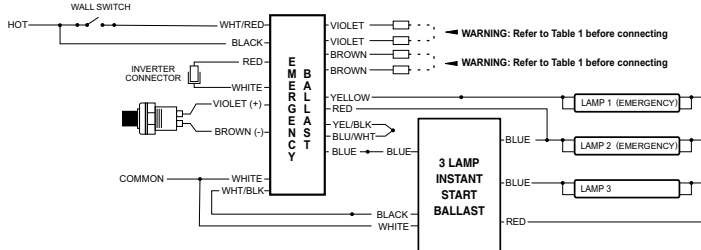

FIG O THREE (3) LAMP RAPID START BALLAST

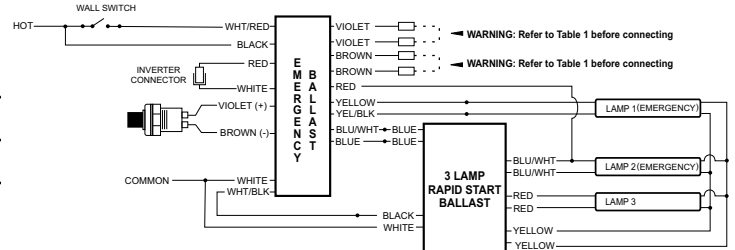

FIG P FOUR (4) LAMP INSTANT START BALLAST

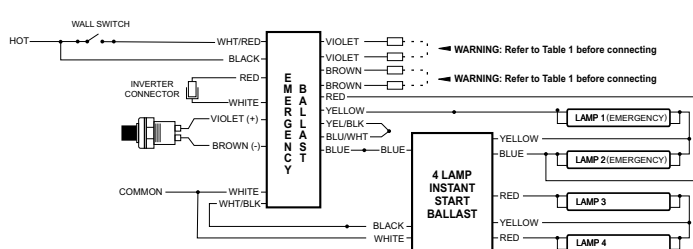
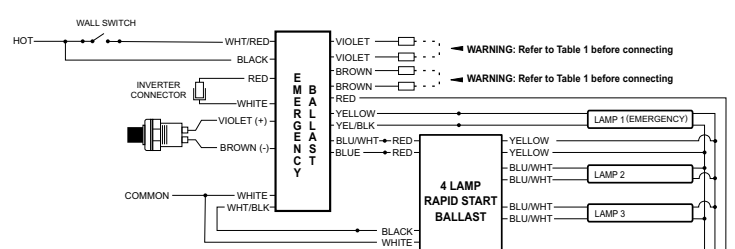

FIG Q FOUR (4) LAMP RAPID START BALLAST



NOTE: Installation of this self-testing fluorescent emergency ballast is different from standard models. The emergency ballast must interrupt the switched or unswitched hot lead feeding the AC ballast. Before beginning installation, consult these wiring diagrams.