

# B60LP

## Installation Instructions

EMERGENCY LIGHTING EQUIPMENT

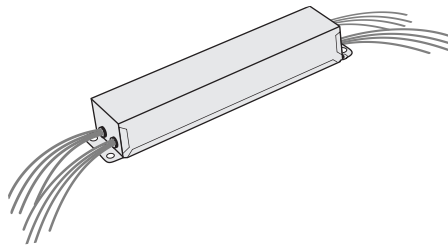

PHILIPS  
bodine



### **! IMPORTANT SAFEGUARDS !**

**WHEN USING ELECTRICAL EQUIPMENT, BASIC SAFETY PRECAUTIONS SHOULD ALWAYS BE FOLLOWED, INCLUDING THE FOLLOWING:**

## **READ AND FOLLOW ALL SAFETY INSTRUCTIONS**

1. To prevent high voltage from being present on red & yellow output leads prior to installation, inverter connector must be open. Do not join inverter connector until installation is complete and AC power is supplied to the emergency ballast.
2. This product is for use with most 2' through 8' (17 W - 215 W) single pin or bipin fluorescent lamps, including energy saving, circline, U-shaped and rapid-start fluorescent lamps.
3. Make sure all connections are in accordance with the National Electrical Code and any local regulations.
4. To reduce the risk of electric shock, disconnect both normal and emergency power supplies and inverter connector of the emergency ballast before servicing.
5. This emergency ballast is for factory or field installation in either the ballast channel or on top of the fixture.
6. This product is suitable for damp locations where the ambient temperature is 0°C minimum, +50°C maximum. Product is also suitable for installation in sealed and gasketed fixtures. Product is not suitable for heated air outlets and wet or hazardous locations.
7. An unswitched AC power source is required (120 or 277 VAC, 60 Hz).
8. Do not install near gas or electric heaters.
9. Do not attempt to service the battery. A sealed, no-maintenance battery is used that is not field replaceable. Contact the manufacturer for information on service.
10. The use of accessory equipment not recommended by the manufacturer may cause an unsafe condition.
11. Do not use this product for other than intended use.
12. Servicing should be performed by qualified service personnel.

**CAUTION:** Verify that all replacement lamp types marked on the installed luminaire are also identified as suitable for use with this inverter/charger pack.

## **SAVE THESE INSTRUCTIONS**

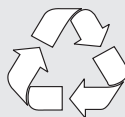

Ni - Cd

**THIS PRODUCT CONTAINS A RECHARGEABLE NICKEL-CADMIUM BATTERY.  
THE BATTERY MUST BE RECYCLED OR DISPOSED OF PROPERLY.**

01/06/15

© Philips Emergency Lighting

# INSTALLATION

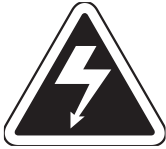

**WARNING: TO PREVENT HIGH VOLTAGE FROM BEING PRESENT ON RED & YELLOW OUTPUT LEADS PRIOR TO INSTALLATION, INVERTER CONNECTOR MUST BE OPEN. DO NOT JOIN INVERTER CONNECTOR UNTIL INSTALLATION IS COMPLETE AND AC POWER IS SUPPLIED TO THE EMERGENCY BALLAST.**

**NOTE:** Make sure the necessary branch circuit wiring is available. An unswitched source of power is required. The emergency ballast must be fed from the same branch circuit as the AC ballast.

## STEP #1 ▶ INSTALLING THE EMERGENCY BALLAST

- > Disconnect AC power from the fixture. Remove the ballast channel cover and install the emergency ballast either in the ballast channel or on top of the fixture. \* **Remote mounting distance must be less than half the maximum remote mounting distance for the AC ballast. Consult AC ballast manufacturer before remote installation.**
- > Depending on the type of fixture in use install emergency ballast using one of the methods illustrated below.

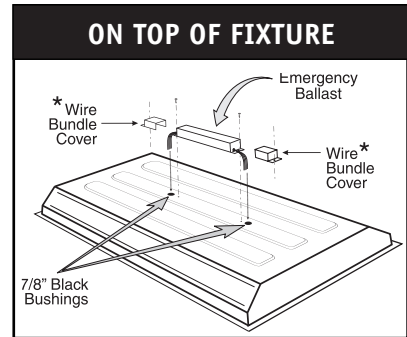
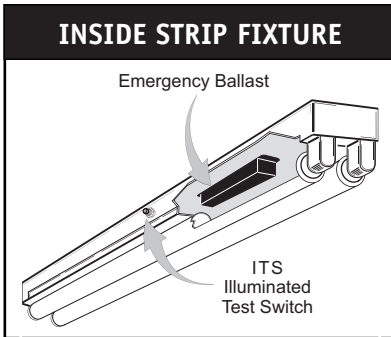
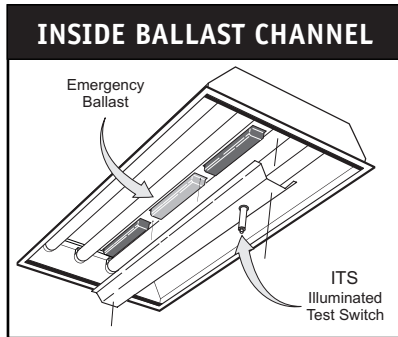

\* For installation on top of the fixture, wire bundle covers (RMC-60) may be required by state or local codes. These covers are available from the manufacturer as an accessory kit and must be ordered separately. Call your local distributor or the factory for complete information.

## STEP #2a ▶ INSTALLING THE ITS ON THE FIXTURE SURFACE

- > Drill a 3/8" hole and install the ITS (illuminated test switch)(e.g. through the side of a surface mounted fixture).
- > After installing, mark with the "PUSH TO TEST" and "CHARGING INDICATOR LIGHT" labels.

## STEP #2b ▶ INSTALLING THE ITS ON THE BALLAST CHANNEL COVER FOR LENSED LUMINAIRE APPLICATIONS

- > Drill or punch a 7/8 inch hole in ballast channel cover and insert-bushing.
- > Slide the ITS tube up or down to adjust the height and visibility of the charging indicator light.
- > If the tube is too long, cut the plastic tubing to necessary length.
- > After cutting the tube to the proper length, assemble the ITS.

### TO ASSEMBLE THE ITS TUBE

- > Remove the washer and hex nut from the ITS.
- > Place the strain relief bushing on the wires back from the tip of the switch approximately the length of the plastic tube.
- > Feed the switch through the plastic tubing and seat the tapered end of the strain relief bushing into the tubing. The threaded end of the switch should protrude slightly from the plastic tubing. If the threaded end of the switch is not extending beyond the end of the plastic tubing or is protruding too far, reposition the strain relief bushing until you achieve the desired result.
- > Place the washer and hex nut back on the switch and tighten.
- > After installing, mark with the "PUSH TO TEST" and "CHARGING INDICATOR LIGHT" labels.

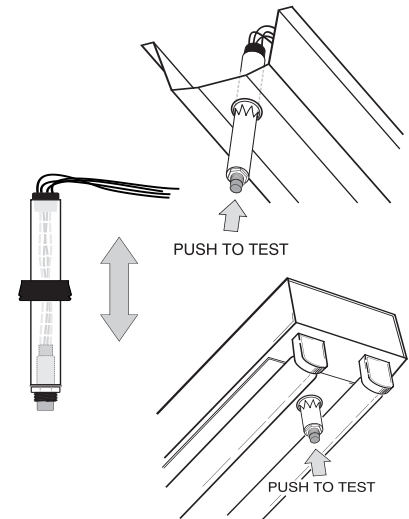
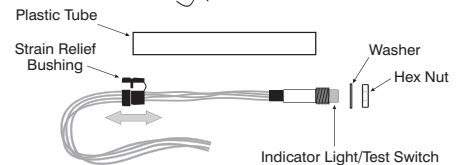
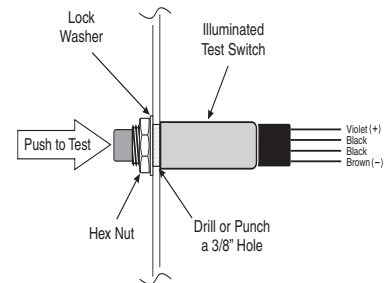

# INSTALLATION

## STEP #3 ► WIRING THE EMERGENCY BALLAST

- > Determine the type of AC ballast installed in the fixture.
- > Select the appropriate wiring diagram (see back page) to connect the emergency ballast to the AC ballast and lamp(s). Make sure all connections are in accordance with the National Electrical Code and any local regulations.
- > After installation is complete, supply AC power to the emergency ballast and join the inverter connector.
- > At this point, power should be connected to both the AC ballast and the emergency ballast, and the Charging Indicator Light on the ITS should illuminate indicating the battery is charging.
- > A short-term discharge test may be conducted after the emergency ballast has been charging for one hour. Charge for 24 hours before conducting a long-term discharge test. Refer to OPERATION.
- > In a readily visible location, attach the label "**CAUTION - This Unit Has More Than One Power Connection Point. To Reduce The Risk Of Electric Shock, Disconnect Both The Branch Circuit-Breakers Or Fuses And Emergency Power Supplies Before Servicing.**"

### Optional - Separate Test Switch and Charging Indicator Light Installation

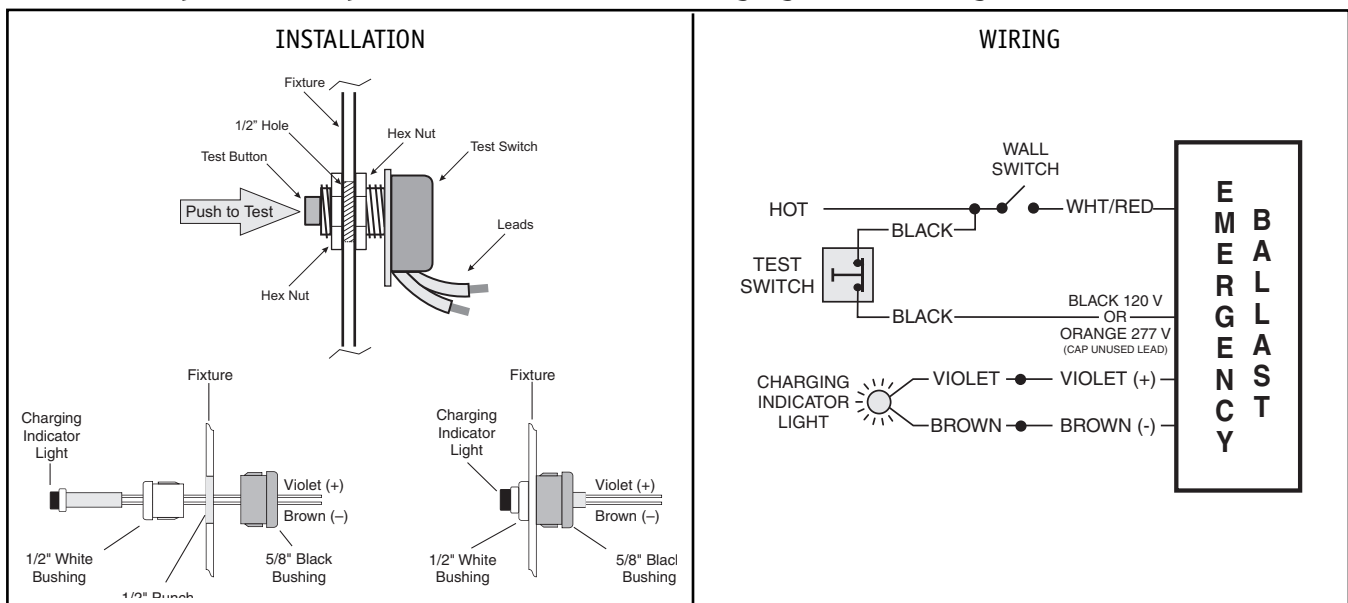

NOTE: After installing the charging indicator light and test switch, mark each with the appropriate label.

## OPERATION

When AC power is applied, the charging indicator light is illuminated, indicating the battery is being charged. When power fails, the emergency ballast automatically switches to emergency power, operating one or two lamps at reduced illumination. When AC power is restored, the emergency ballast returns to the charging mode and delays AC ballast operation for approximately three seconds to prevent false-tripping of AC ballast (end-of-lamp-life) shutdown circuits. This emergency ballast will operate the rated lamp load for a minimum of 90 minutes.

## MAINTENANCE

Although no routine maintenance is required to keep the emergency ballast functional, it should be checked periodically to ensure that it is working. The following schedule is recommended:

1. Visually inspect the charging indicator light monthly. It should be illuminated.
2. Test the emergency operation of the fixture at 30-day intervals for a minimum of 30 seconds. One or two lamps should operate at reduced illumination.
3. Conduct a 90-minute discharge test once a year. One or two lamps should operate at reduced illumination for at least 90 minutes.

**! REFER ANY SERVICING INDICATED BY THESE CHECKS TO QUALIFIED PERSONNEL !**

**EMERGENCY BALLAST AND AC BALLAST MUST BE FED FROM THE SAME BRANCH CIRCUIT**  
 TYPICAL SCHEMATICS ONLY. MAY BE USED WITH OTHER BALLASTS. CONSULT THE FACTORY FOR OTHER WIRING DIAGRAMS.

## WIRING DIAGRAM for 1-LAMP emergency operation

FIG A TWO (2) LAMP INSTANT START BALLAST

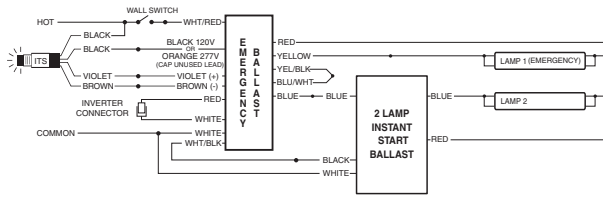

FIG B TWO (2) LAMP RAPID START BALLAST

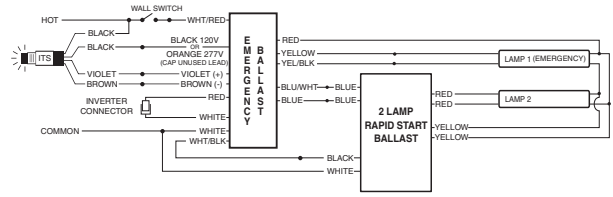

FIG C THREE (3) LAMP INSTANT START BALLAST

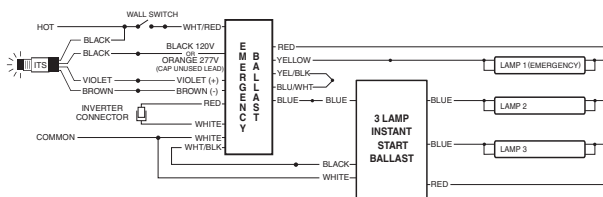

FIG D THREE (3) LAMP RAPID START BALLAST

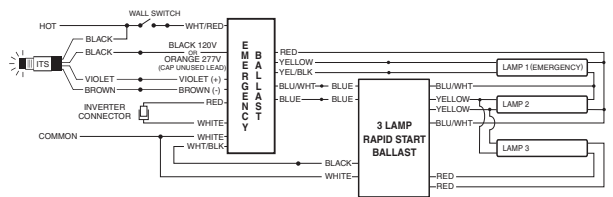

FIG E FOUR (4) LAMP INSTANT START BALLAST

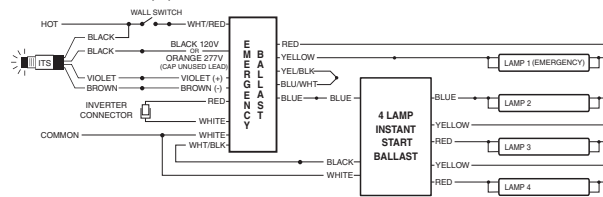

FIG F FOUR (4) LAMP RAPID START BALLAST

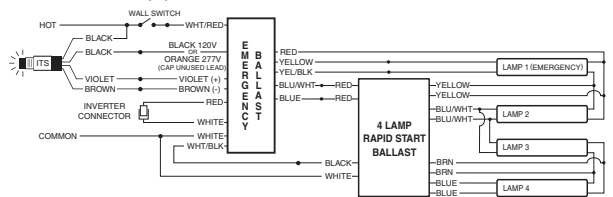
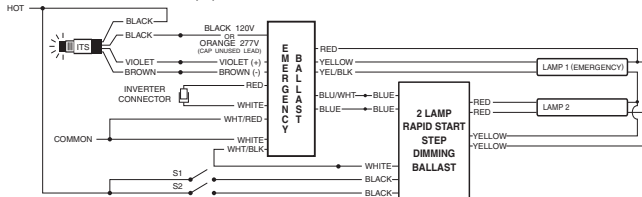

FIG G TWO (2) LAMP RAPID START STEP DIMMING BALLAST



THE WHITE/BLACK LEAD MUST CONNECT TO THE WHITE LEAD OF THE STEP-DIMMING BALLAST ASSOCIATED WITH THE EMERGENCY BALLAST ONLY. CONNECTIONS TO OTHER BALLASTS OR FIXTURES COULD RESULT IN ABNORMAL OPERATION AND CAUSE PRODUCT DAMAGE.

## WIRING DIAGRAMS for 2-LAMP emergency operation (2' - 4', 17- 40 W lamps only)

FIG H TWO (2) LAMP INSTANT START BALLAST

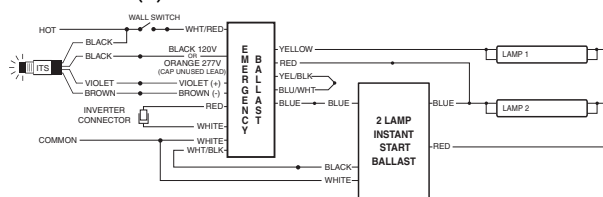

FIG I TWO (2) LAMP RAPID START BALLAST

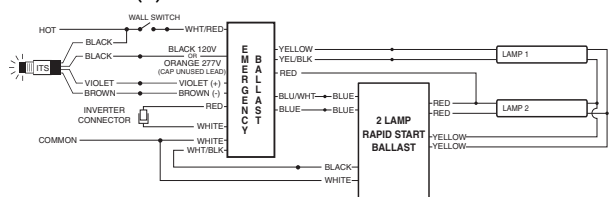

FIG J THREE (3) LAMP INSTANT START BALLAST

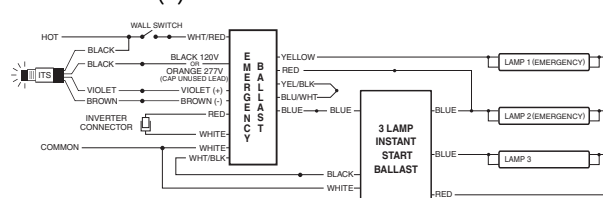
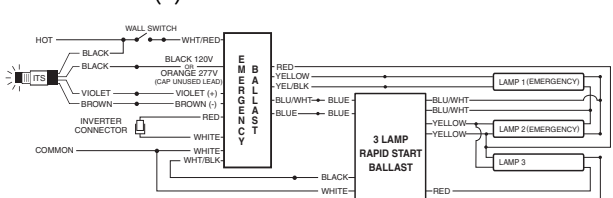

FIG K THREE (3) LAMP RAPID START BALLAST



## WIRING DIAGRAMS for Emergency-Only fixtures

FIG L ONE (1) 32-215 W LAMP WITHOUT AC BALLAST

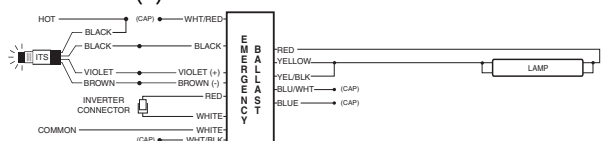

FIG M TWO (2) 17-40 W LAMPS WITHOUT AC BALLAST

