

# BHD65U

## Installation Instructions

EMERGENCY LIGHTING EQUIPMENT

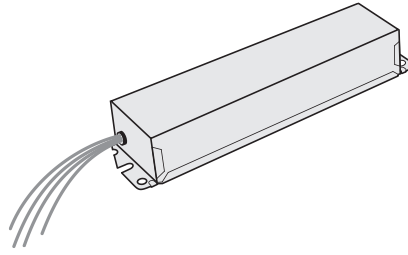

PHILIPS  
**bodine**



### **! IMPORTANT SAFEGUARDS !**

WHEN USING ELECTRICAL EQUIPMENT, BASIC SAFETY PRECAUTIONS SHOULD ALWAYS BE FOLLOWED, INCLUDING THE FOLLOWING:

## READ AND FOLLOW ALL SAFETY INSTRUCTIONS

1. To prevent high voltage from being present on red & yellow output leads prior to installation, inverter connector must be open. Do not join inverter connector until installation is complete and AC power is supplied to the emergency ballast.
2. This product is for use with two 17-40 W (2'-4') T8, T10, or T12 fluorescent lamps or one 17-215 W (2'-8') T8, T10, or T12 fluorescent lamp.
3. Make sure all connections are in accordance with the National Electrical Code and any local regulations.
4. To reduce the risk of electric shock, disconnect both normal and emergency power supplies and inverter connector of the emergency ballast before servicing.
5. This emergency ballast is for factory installation only.
6. This product is suitable for damp locations where the ambient temperature for fixture is 0°C minimum, +50°C maximum. This product is suitable for use in sealed and gasketed fixtures.
7. An unswitched AC power source is required (120 through 277 VAC, 50 or 60 Hz).
8. Do not install near gas or electric heaters.
9. Do not attempt to service the battery. A sealed, no-maintenance battery is used that is not field replaceable. Contact the manufacturer for information on service.
10. The use of accessory equipment not recommended by the manufacturer may cause an unsafe condition.
11. Do not use this product for other than intended use.
12. Servicing should be performed by qualified service personnel.

**CAUTION:** Verify that all replacement lamp types marked on the installed luminaire are also identified as suitable for use with this inverter/charger pack.

## SAVE THESE INSTRUCTIONS

THIS COMPONENT IS INCOMPLETE IN CERTAIN CONSTRUCTION FEATURES OR RESTRICTED IN PERFORMANCE CAPABILITIES AND NOT INTENDED FOR SEPARATE INSTALLATION IN THE FIELD; RATHER IT IS INTENDED FOR USE AS A COMPONENT OF COMPLETE EQUIPMENT SUBMITTED FOR INVESTIGATION BY UNDERWRITERS LABORATORIES INC. FINAL ACCEPTANCE OF THE COMPONENT IN THE COMPLETE EQUIPMENT IS DEPENDENT UPON ITS INSTALLATION AND USE IN ACCORDANCE WITH ALL APPLICABLE USE CONDITIONS AND RATINGS NOTED IN THE COMPONENT REPORT ISSUED BY UNDERWRITERS LABORATORIES INC.



**THIS PRODUCT CONTAINS A RECHARGEABLE NICKEL-CADMIUM BATTERY.  
THE BATTERY MUST BE RECYCLED OR DISPOSED OF PROPERLY.**

09/03/14

© Philips Emergency Lighting

236 Mt. Pleasant Rd. • Collierville, TN USA 38017-2752 • Tech Support 888-263-4638 • Fax 901-853-5009 • www.bodine.com  
76000046

# INSTALLATION

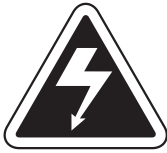

**WARNING: TO PREVENT HIGH VOLTAGE FROM BEING PRESENT ON RED & YELLOW OUTPUT LEADS PRIOR TO INSTALLATION, INVERTER CONNECTOR MUST BE OPEN. DO NOT JOIN INVERTER CONNECTOR UNTIL INSTALLATION IS COMPLETE AND AC POWER IS SUPPLIED TO THE EMERGENCY BALLAST.**

**NOTE:** Make sure the necessary branch circuit wiring is available. An unswitched source of power is required. The emergency ballast must be fed from the same branch circuit as the AC ballast.

## STEP #1 ▶ INSTALLING THE EMERGENCY BALLAST

- > Disconnect AC power from the fixture.
- > Install the emergency ballast either in the ballast channel or on top of the fixture. **Remote mounting distance must be less than half the maximum remote mounting distance of the AC ballast. Consult AC ballast manufacturer before remote installation.**
- > Refer to the illustration showing basic switched and unswitched fixture connections. See back page for more detailed wiring schematics. The emergency ballast can be used to operate one or two lamps in emergency mode.

## STEP #2 ▶ INSTALLING THE TEST SWITCH

- > Refer to the diagrams and wire the test switch so that it removes AC power from both the emergency ballast and the AC ballast at the same time.

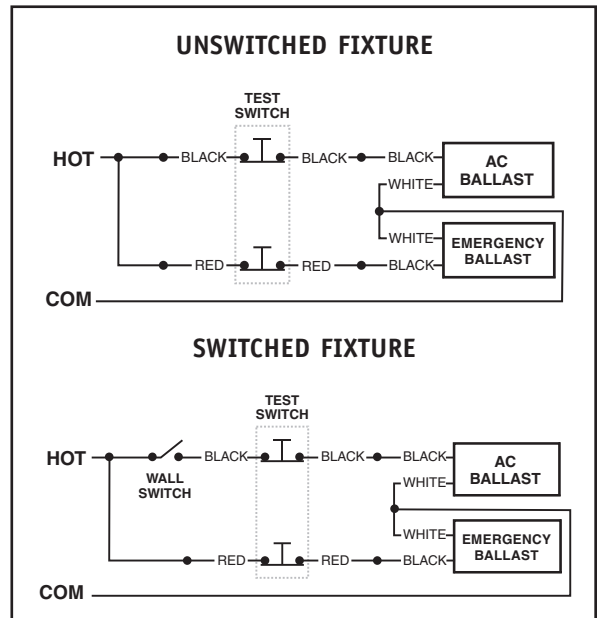

On switched fixtures, an additional unswitched hot wire must be run to the fixture and connected to the emergency ballast.

## STEP #3 ▶ INSTALLING THE CHARGING INDICATOR LIGHT

- > Install the CHARGING INDICATOR LIGHT as shown in the illustration so that it will be visible after the fixture is installed.
- > **NOTE:** After installing the charging indicator light and test switch, mark each with the appropriate label. If a detached charging indicator light is used, connect by matching wire colors and install as shown.

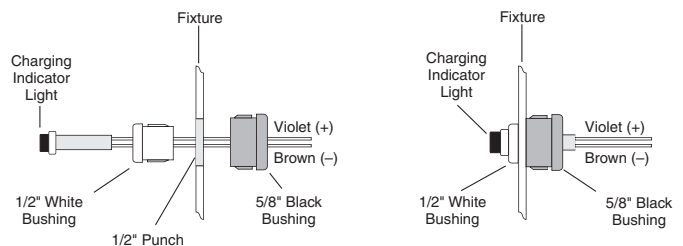

STEP 1

STEP 2

## STEP #4 ▶ WIRING THE EMERGENCY BALLAST

- > Select the appropriate wiring diagram on the following pages to connect the emergency ballast to the AC ballast and lamp.
- > The emergency ballast must be connected to an unswitched power source (120 to 277 VAC). Do not connect to other voltages. After fixture installation is complete, supply AC power to the emergency ballast and join the inverter connector.
- > For short-term testing of the emergency function, the battery must be charged for at least one hour. The emergency ballast must be charged for at least 24 hours before conducting a long-term test.
- > In a readily visible location, attach the label **"CAUTION - This Unit Has More Than One Power Supply Connection Point. To Reduce The Risk Of Electric Shock, Disconnect Both The Branch Circuit-Breakers Or Fuses And Emergency Power Supplies Before Servicing."**

# OPERATION

When AC power is applied, the charging indicator light is illuminated, indicating that the battery is being charged. When power fails, the emergency ballast automatically switches to emergency power (internal battery), operating one or two lamps at reduced illumination for at least 90 minutes. A minimum of 120 minutes of emergency illumination is produced with one 32 W T8 fluorescent lamp.

# MAINTENANCE

Although no routine maintenance is required to keep the emergency ballast functional, it should be checked periodically to ensure that it is working. The following schedule is recommended:

1. Visually inspect the charging indicator light monthly. It should be illuminated.
2. Test the emergency operation of the fixture at 30-day intervals for a minimum of 30 seconds. One or two lamps should operate at reduced illumination.
3. Conduct a 90-minute discharge test once a year. One or two lamps should operate at reduced illumination for at least 90 minutes.

**! REFER ANY SERVICING INDICATED BY THESE CHECKS TO QUALIFIED PERSONNEL !**

**EMERGENCY BALLAST AND AC BALLAST MUST BE FED FROM THE SAME BRANCH CIRCUIT**  
 TYPICAL SCHEMATICS ONLY. MAY BE USED WITH OTHER BALLASTS. CONSULT THE FACTORY FOR OTHER WIRING DIAGRAMS.

## WIRING DIAGRAMS for 2-LAMP emergency operation

FIG A TWO (2) LAMP INSTANT START BALLAST  
 (2'-4' T8, T10, T12 LAMPS ONLY)

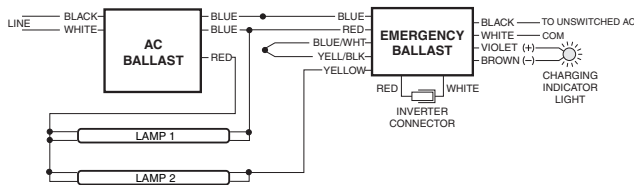

FIG B TWO (2) LAMP RAPID START BALLAST  
 (2'-4' T8, T10, T12 LAMPS ONLY)

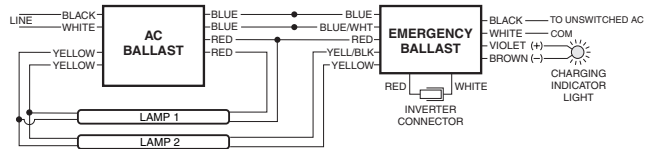
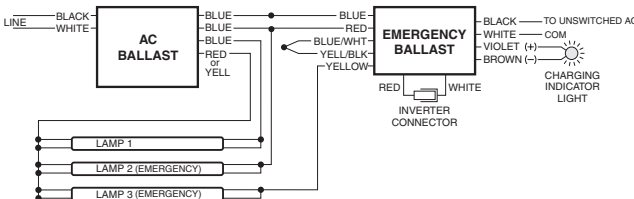

FIG C THREE (3) LAMP INSTANT START BALLAST  
 (2'-4' T8, T10, T12 LAMPS ONLY)



## WIRING DIAGRAMS for Emergency-Only fixtures

FIG D ONE (1) LAMP (17-215 W) WITHOUT AC BALLAST

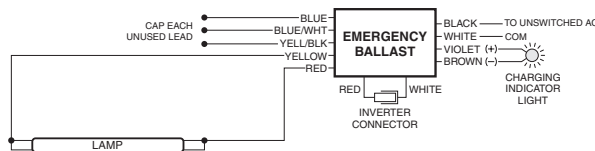

FIG E TWO (2) LAMPS WITHOUT AC BALLAST  
 (2'-4' T8, T10, T12 LAMPS ONLY)

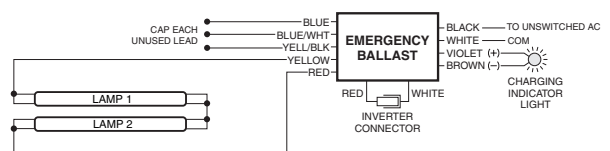
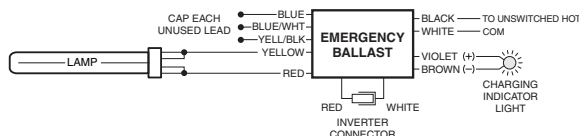

FIG F ONE (1) LAMP (18-40 W 4-PIN) WITHOUT AC BALLAST



**EMERGENCY BALLAST AND AC BALLAST MUST BE FED FROM THE SAME BRANCH CIRCUIT**  
 TYPICAL SCHEMATICS ONLY. MAY BE USED WITH OTHER BALLASTS. CONSULT THE FACTORY FOR OTHER WIRING DIAGRAMS.

**WIRING DIAGRAM for 1-LAMP emergency operation**

FIG G ONE (1) LAMP RAPID START BALLAST

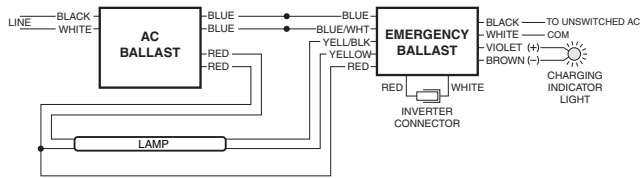

FIG H TWO (2) LAMP RAPID START BALLAST

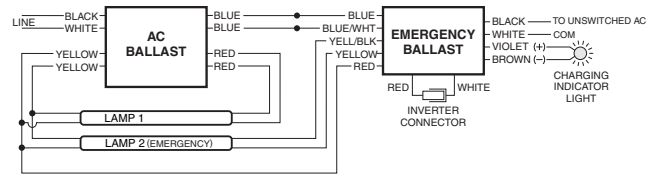

FIG I ONE (1) LAMP INSTANT START BALLAST

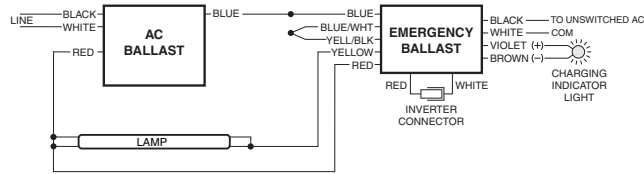

FIG J TWO (2) LAMP INSTANT START BALLAST

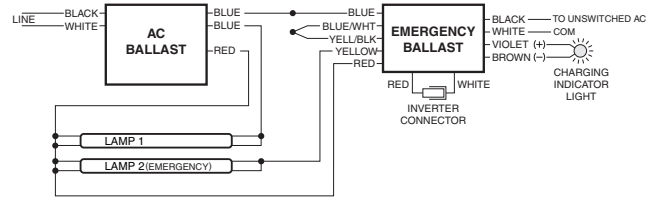

FIG K THREE (3) LAMP RAPID START BALLAST

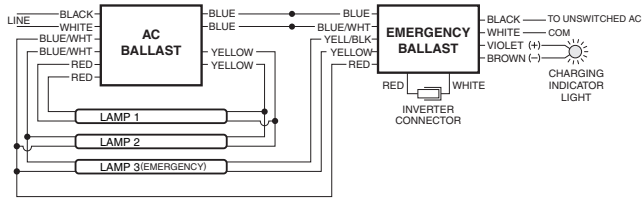

FIG L THREE (3) LAMP INSTANT START BALLAST

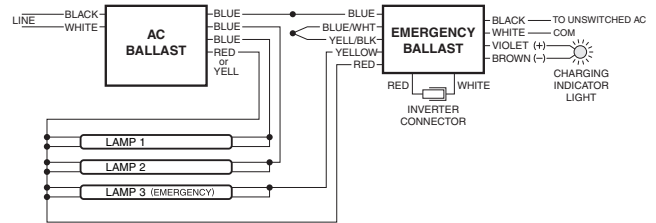

FIG M FOUR (4) LAMP INSTANT START BALLAST

